

IP 67
ACCORDING TO
EN 60529:1991+A1:2001
IEC 60529:2001

C US
E 187490

RoHS
compliant

Pb
lead-free

SPECIFICATIONS

CONTACT RATING: Dependent upon contact material See Page 77.

MECHANICAL LIFE: 50,000 make-and-break cycles.

CONTACT RESISTANCE: 20 mΩ max. initial @ 2-4VDC
100mA for both silver and gold plated contacts.

INSULATION RESISTANCE: 1,000 MΩ min.

DIELECTRIC STRENGTH: 1,000 Vrms min. @ sea level.

OPERATING TEMPERATURE: -30°C to 85°C.

MATERIALS

CASE & BUSHING: Glass filled nylon 6/6, flame retardant,
heat stabilized (UL94v-0).

ACTUATOR: Nylon black std, internal O-ring seal standard with
all actuators.

SWITCH SUPPORT: Brass, tin plated.

CONTACT / TERMINALS: Copper alloy, with Silver or gold plated.
(See Page 77)

HOW TO ORDER

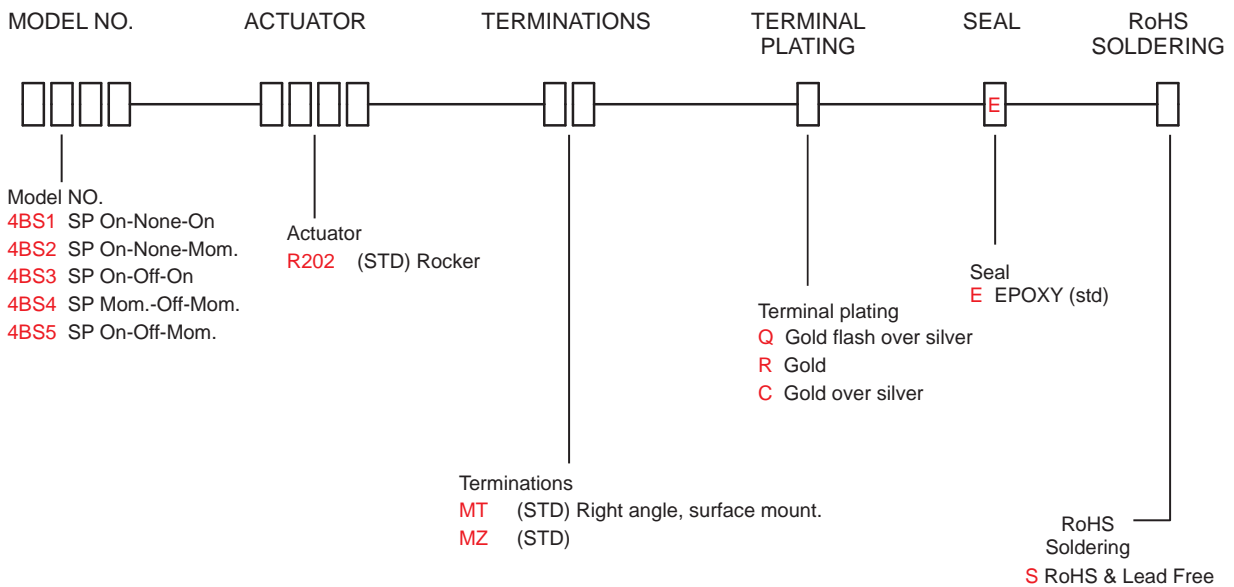

4B Series

Sealed Sub-Miniature Rocker Switches(SMT)

SWITCH FUNCTION

NO. POLES	UL/CSA MODEL NO.	MODEL NO.	SWITCH FUNCTION			CONNECTED TERMINALS / SCHEMATIC		
			POS.1	POS.2	POS.3	POS.1	POS.2	POS.3
SP	Q24B11	4BS1	ON	NONE	ON	2-3	N/A	2-1
	Q24B12	4BS2	ON	NONE	MOM			
	Q24B13	4BS3	ON	OFF	ON			
	Q24B14	4BS4	MOM	OFF	MOM			
	Q24B15	4BS5	ON	OFF	MOM			OPEN

MOM=MOMENTARY

POLE OPTIONS

MT

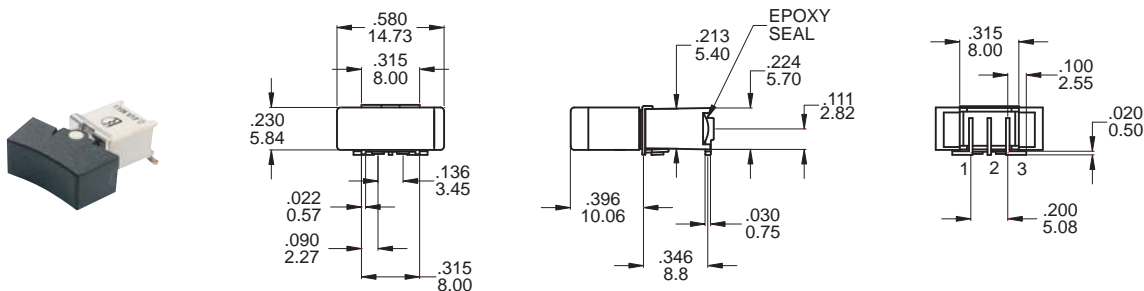

SPDT

Part No. Shown : 4BS1R202MTRES

MZ

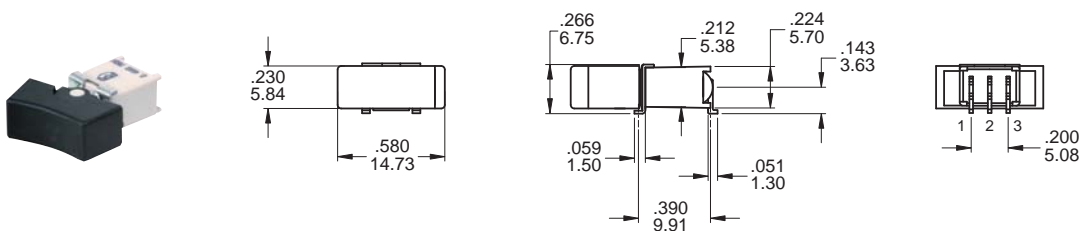

SPDT

Part No. Shown : 4BS1R202MZRES

P.C. MOUNTING

MT

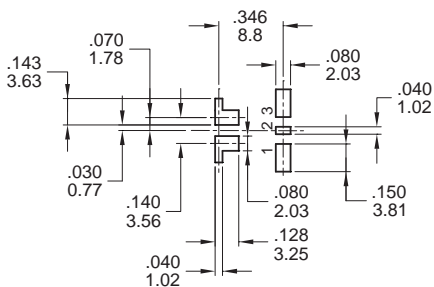

MZ

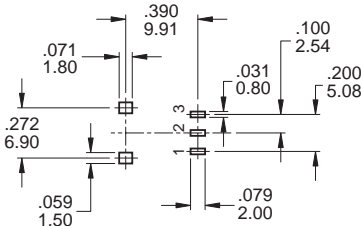

PACKAGING

Switches available on embossed antistatic tape and reels.

Tape and cover strip are conductive for use near statically sensitive components.

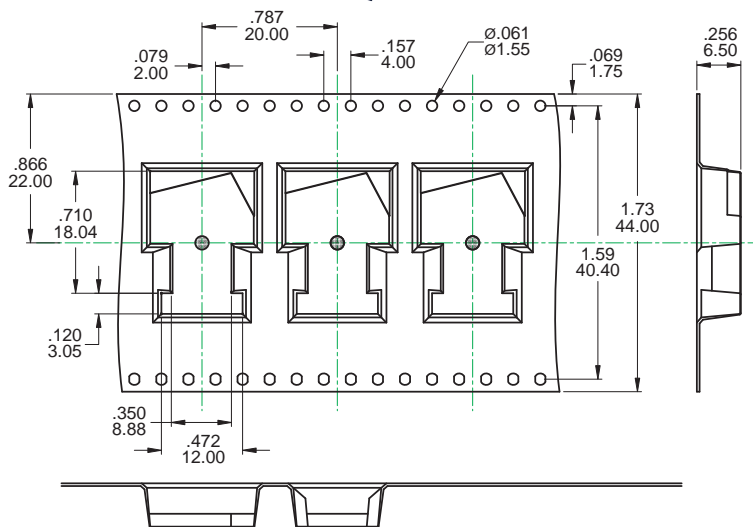

SCALE: 1 : 1

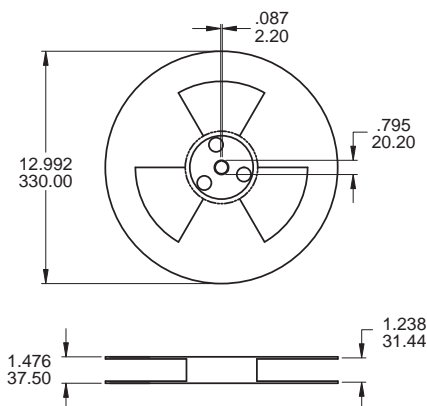

SCALE: 10 : 1

REEL INFORMATION	
QUANTITY PER REEL	450 / pcs

CONTACT MATERIAL OPTIONS

	CONTACT PLATING	TERMINAL PLATING	RATINGS
Q	Silver	Q = Gold flash over silver	3 Amps with resistant load @ 120VAC or 28VDC 1 Amps with resistant load @ 250VAC
C	Gold over Silver	C = Gold over silver	
R	Gold	R = Gold	0.4 Volt - Amps (VA) max. @ 20V max. (AC or DC)

SOLDERING PROCESSES

REFLOW SOLDERING:

Recommended Soldering Temperature: $260 \pm 5^\circ\text{C}$

Duration of Solder Immersion: Max 5 sec.

(PCB is 1.6mm in thickness)

SOLDERING: Vapor phase & IR-reflow soldering can be applied.

Temperature Profile

Zone	Room Temperature	Time (Sec)
Pre-heat (A)	150°C	Min 120s
Soak (B)	150°C ~ 200°C	Min 150s
Peak (C)	200°C ~ 235°C	Min 30s
Peak (D)	235°C ~ 260°C	Min 40s
Peak (E)	260°C	Max 5s

